

Preisliste RIS 2011

Rohr-Installationssysteme

Gültig ab 1. Januar 2011

Roth

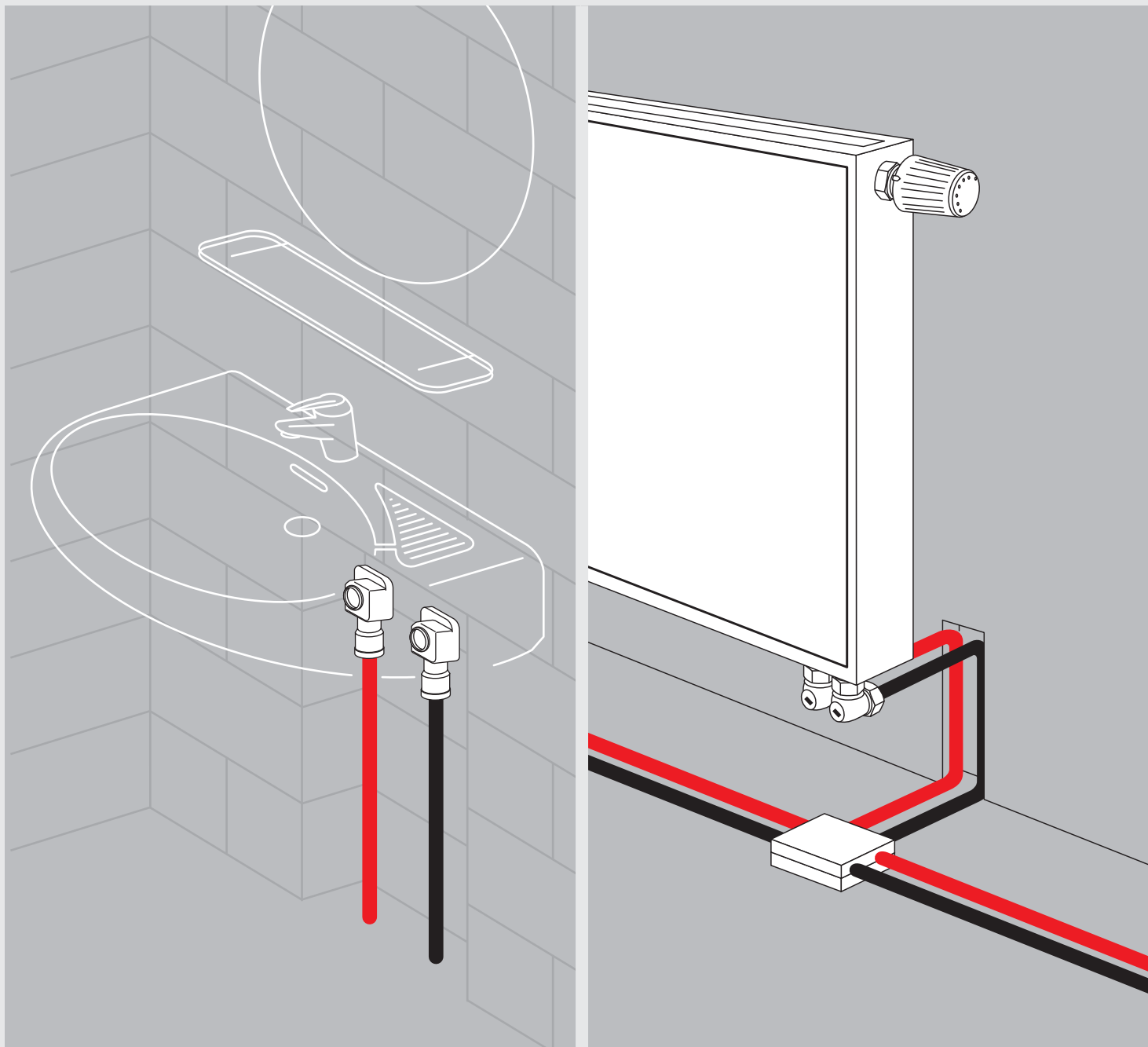

DVGW DW-8236 BP 5589



DVGW DW-8501 AT 2384



DVGW DW-8501 BL 0335



DVGW DW-8501 BR 0036



DVGW DW-8501 BR 0037

ENERGIE- UND SANITÄRSYSTEME

RIS Roth RIS Systemrohre Preisgruppe RIS

Artikel	Artikelbeschreibung	Heizung	Sanitär	Material-Nr.	Preis €uro																																																																																																					
	<p>Roth Systemrohr Alu-Laserplus® Die Verbindung eines hochwertigen, dickwandigen PE-Basisrohres zur Wasserführung, mit einer lasergeschweißten homogenen Aluminiumschicht für erhöhte Festigkeit und als Sauerstoffsperrschicht sowie einer zusätzlichen PE-Schutzschicht.</p>																																																																																																									
	<table border="0"> <tr> <td>Dimension</td> <td>Ringmaterial</td> <td>Verpackungseinheit</td> <td></td> <td></td> <td>€uro/m</td> </tr> <tr> <td>14 mm</td> <td></td> <td>100 m</td> <td></td> <td></td> <td>2,40</td> </tr> <tr> <td>14 mm</td> <td></td> <td>200 m</td> <td></td> <td></td> <td>2,40</td> </tr> <tr> <td>17 mm</td> <td></td> <td>100 m</td> <td></td> <td></td> <td>2,50</td> </tr> <tr> <td>17 mm</td> <td></td> <td>200 m</td> <td></td> <td></td> <td>2,50</td> </tr> <tr> <td>17 mm</td> <td></td> <td>600 m</td> <td></td> <td></td> <td>2,50</td> </tr> <tr> <td>20 mm</td> <td></td> <td>50 m</td> <td></td> <td></td> <td>3,40</td> </tr> <tr> <td>20 mm</td> <td></td> <td>100 m</td> <td></td> <td></td> <td>3,40</td> </tr> <tr> <td>25 mm</td> <td></td> <td>25 m</td> <td></td> <td></td> <td>6,90</td> </tr> <tr> <td>Dimension</td> <td>Stange</td> <td>Verpackungseinheit</td> <td></td> <td></td> <td></td> </tr> <tr> <td>17 mm</td> <td>5 m</td> <td>20 Stück/Hülse</td> <td></td> <td></td> <td>3,60</td> </tr> <tr> <td>20 mm</td> <td>5 m</td> <td>16 Stück/Hülse</td> <td></td> <td></td> <td>4,60</td> </tr> <tr> <td>25 mm</td> <td>5 m</td> <td>10 Stück/Hülse</td> <td></td> <td></td> <td>7,50</td> </tr> <tr> <td>32 mm</td> <td>5 m</td> <td>9 Stück/Hülse</td> <td></td> <td></td> <td>10,90</td> </tr> <tr> <td>40 mm</td> <td>5 m</td> <td>4 Stück/Hülse</td> <td></td> <td></td> <td>20,20</td> </tr> <tr> <td>50 mm</td> <td>5 m</td> <td>3 Stück/Hülse</td> <td></td> <td></td> <td>26,40</td> </tr> <tr> <td>63 mm</td> <td>5 m</td> <td>3 Stück/Hülse</td> <td></td> <td></td> <td>38,30</td> </tr> </table>	Dimension	Ringmaterial	Verpackungseinheit			€uro/m	14 mm		100 m			2,40	14 mm		200 m			2,40	17 mm		100 m			2,50	17 mm		200 m			2,50	17 mm		600 m			2,50	20 mm		50 m			3,40	20 mm		100 m			3,40	25 mm		25 m			6,90	Dimension	Stange	Verpackungseinheit				17 mm	5 m	20 Stück/Hülse			3,60	20 mm	5 m	16 Stück/Hülse			4,60	25 mm	5 m	10 Stück/Hülse			7,50	32 mm	5 m	9 Stück/Hülse			10,90	40 mm	5 m	4 Stück/Hülse			20,20	50 mm	5 m	3 Stück/Hülse			26,40	63 mm	5 m	3 Stück/Hülse			38,30			
Dimension	Ringmaterial	Verpackungseinheit			€uro/m																																																																																																					
14 mm		100 m			2,40																																																																																																					
14 mm		200 m			2,40																																																																																																					
17 mm		100 m			2,50																																																																																																					
17 mm		200 m			2,50																																																																																																					
17 mm		600 m			2,50																																																																																																					
20 mm		50 m			3,40																																																																																																					
20 mm		100 m			3,40																																																																																																					
25 mm		25 m			6,90																																																																																																					
Dimension	Stange	Verpackungseinheit																																																																																																								
17 mm	5 m	20 Stück/Hülse			3,60																																																																																																					
20 mm	5 m	16 Stück/Hülse			4,60																																																																																																					
25 mm	5 m	10 Stück/Hülse			7,50																																																																																																					
32 mm	5 m	9 Stück/Hülse			10,90																																																																																																					
40 mm	5 m	4 Stück/Hülse			20,20																																																																																																					
50 mm	5 m	3 Stück/Hülse			26,40																																																																																																					
63 mm	5 m	3 Stück/Hülse			38,30																																																																																																					
	<p>Roth Systemrohr Alu-Laserplus® im PE-Schutzrohr Wie vor, jedoch im PE-Schutzrohr (braun).</p>																																																																																																									
	<table border="0"> <tr> <td>Dimension</td> <td>Ringmaterial</td> <td>Verpackungseinheit</td> <td></td> <td></td> <td>€uro/m</td> </tr> <tr> <td>14 mm (Schutzrohr 16/21)</td> <td></td> <td>50 m</td> <td></td> <td></td> <td>3,40</td> </tr> <tr> <td>17 mm (Schutzrohr 20/25)</td> <td></td> <td>50 m</td> <td></td> <td></td> <td>3,70</td> </tr> <tr> <td>20 mm (Schutzrohr 23/28)</td> <td></td> <td>50 m</td> <td></td> <td></td> <td>4,90</td> </tr> </table>	Dimension	Ringmaterial	Verpackungseinheit			€uro/m	14 mm (Schutzrohr 16/21)		50 m			3,40	17 mm (Schutzrohr 20/25)		50 m			3,70	20 mm (Schutzrohr 23/28)		50 m			4,90																																																																																	
Dimension	Ringmaterial	Verpackungseinheit			€uro/m																																																																																																					
14 mm (Schutzrohr 16/21)		50 m			3,40																																																																																																					
17 mm (Schutzrohr 20/25)		50 m			3,70																																																																																																					
20 mm (Schutzrohr 23/28)		50 m			4,90																																																																																																					
	<p>Roth Systemrohr Alu-Laserplus® mit Wärmedämmung Roth Systemrohre Alu-Laserplus® mit 6 mm starker symmetrischer PE-Rohrdämmung (WLG 040) für Anforderungen nach DIN 1988.</p>																																																																																																									
	<table border="0"> <tr> <td>Dimension</td> <td>Ringmaterial</td> <td>Verpackungseinheit</td> <td></td> <td></td> <td>€uro/m</td> </tr> <tr> <td>14 mm</td> <td></td> <td>50 m</td> <td></td> <td></td> <td>4,80</td> </tr> <tr> <td>17 mm</td> <td></td> <td>50 m</td> <td></td> <td></td> <td>5,10</td> </tr> <tr> <td>20 mm</td> <td></td> <td>50 m</td> <td></td> <td></td> <td>6,80</td> </tr> <tr> <td>25 mm</td> <td></td> <td>50 m</td> <td></td> <td></td> <td>11,50</td> </tr> </table>	Dimension	Ringmaterial	Verpackungseinheit			€uro/m	14 mm		50 m			4,80	17 mm		50 m			5,10	20 mm		50 m			6,80	25 mm		50 m			11,50																																																																											
Dimension	Ringmaterial	Verpackungseinheit			€uro/m																																																																																																					
14 mm		50 m			4,80																																																																																																					
17 mm		50 m			5,10																																																																																																					
20 mm		50 m			6,80																																																																																																					
25 mm		50 m			11,50																																																																																																					
	<p>Roth Systemrohre Alu-Laserplus® mit 9 mm starker symmetrischer PE-Rohrdämmung (WLG 040) gemäss EnEV und DIN 1988.</p>																																																																																																									
	<table border="0"> <tr> <td>Dimension</td> <td>Ringmaterial</td> <td>Verpackungseinheit</td> <td></td> <td></td> <td>€uro/m</td> </tr> <tr> <td>14 mm</td> <td></td> <td>50 m</td> <td></td> <td></td> <td>4,90</td> </tr> <tr> <td>17 mm</td> <td></td> <td>50 m</td> <td></td> <td></td> <td>5,20</td> </tr> <tr> <td>20 mm</td> <td></td> <td>50 m</td> <td></td> <td></td> <td>6,80</td> </tr> <tr> <td>25 mm</td> <td></td> <td>25 m</td> <td></td> <td></td> <td>10,20</td> </tr> </table>	Dimension	Ringmaterial	Verpackungseinheit			€uro/m	14 mm		50 m			4,90	17 mm		50 m			5,20	20 mm		50 m			6,80	25 mm		25 m			10,20																																																																											
Dimension	Ringmaterial	Verpackungseinheit			€uro/m																																																																																																					
14 mm		50 m			4,90																																																																																																					
17 mm		50 m			5,20																																																																																																					
20 mm		50 m			6,80																																																																																																					
25 mm		25 m			10,20																																																																																																					
	<p>Roth Systemrohre Alu-Laserplus® mit asymmetrischer PE-Rohrdämmung 9 mm (WLG 040) gemäss EnEV, für Leitungen im Fußbodenaufbau zwischen beheizten Räumen verschiedener Nutzer mit niedrigen Aufbauhöhen.</p>																																																																																																									
	<table border="0"> <tr> <td>Dimension</td> <td>Ringmaterial</td> <td>Verpackungseinheit</td> <td></td> <td></td> <td>€uro/m</td> </tr> <tr> <td>17 mm</td> <td></td> <td>25 m</td> <td></td> <td></td> <td>6,80</td> </tr> <tr> <td>20 mm</td> <td></td> <td>25 m</td> <td></td> <td></td> <td>8,40</td> </tr> </table>	Dimension	Ringmaterial	Verpackungseinheit			€uro/m	17 mm		25 m			6,80	20 mm		25 m			8,40																																																																																							
Dimension	Ringmaterial	Verpackungseinheit			€uro/m																																																																																																					
17 mm		25 m			6,80																																																																																																					
20 mm		25 m			8,40																																																																																																					
	<p>Roth Systemrohre Alu-Laserplus® mit asymmetrischer PE-Rohrdämmung 100 % (WLG 040) gemäss EnEV.</p>																																																																																																									
	<table border="0"> <tr> <td>Dimension</td> <td>Ringmaterial</td> <td>Verpackungseinheit</td> <td></td> <td></td> <td>€uro/m</td> </tr> <tr> <td>14 mm</td> <td></td> <td>25 m</td> <td></td> <td></td> <td>9,30</td> </tr> <tr> <td>17 mm</td> <td></td> <td>25 m</td> <td></td> <td></td> <td>9,50</td> </tr> <tr> <td>20 mm</td> <td></td> <td>25 m</td> <td></td> <td></td> <td>11,90</td> </tr> </table>	Dimension	Ringmaterial	Verpackungseinheit			€uro/m	14 mm		25 m			9,30	17 mm		25 m			9,50	20 mm		25 m			11,90																																																																																	
Dimension	Ringmaterial	Verpackungseinheit			€uro/m																																																																																																					
14 mm		25 m			9,30																																																																																																					
17 mm		25 m			9,50																																																																																																					
20 mm		25 m			11,90																																																																																																					
	<p>Roth PE-Schutzrohr (braun) PE-Wellrohr zum Schutz der Roth PE-Systemrohre und Roth Systemrohre Alu-Laserplus®.</p>																																																																																																									
	<table border="0"> <tr> <td>Dimension</td> <td>Ringmaterial</td> <td>Verpackungseinheit</td> <td></td> <td></td> <td>€uro/m</td> </tr> <tr> <td>14 mm (Schutzrohr 16/21)</td> <td></td> <td>75 m/Rolle</td> <td></td> <td></td> <td>0,82</td> </tr> <tr> <td>17 mm (Schutzrohr 20/25)</td> <td></td> <td>75 m/Rolle</td> <td></td> <td></td> <td>1,10</td> </tr> <tr> <td>20 mm (Schutzrohr 23/28)</td> <td></td> <td>50 m/Rolle</td> <td></td> <td></td> <td>1,40</td> </tr> <tr> <td>25 mm (Schutzrohr 28/34)</td> <td></td> <td>25 m/Rolle</td> <td></td> <td></td> <td>1,60</td> </tr> <tr> <td>32 mm (Schutzrohr 36/42)</td> <td></td> <td>25 m/Rolle</td> <td></td> <td></td> <td>2,30</td> </tr> </table>	Dimension	Ringmaterial	Verpackungseinheit			€uro/m	14 mm (Schutzrohr 16/21)		75 m/Rolle			0,82	17 mm (Schutzrohr 20/25)		75 m/Rolle			1,10	20 mm (Schutzrohr 23/28)		50 m/Rolle			1,40	25 mm (Schutzrohr 28/34)		25 m/Rolle			1,60	32 mm (Schutzrohr 36/42)		25 m/Rolle			2,30																																																																					
Dimension	Ringmaterial	Verpackungseinheit			€uro/m																																																																																																					
14 mm (Schutzrohr 16/21)		75 m/Rolle			0,82																																																																																																					
17 mm (Schutzrohr 20/25)		75 m/Rolle			1,10																																																																																																					
20 mm (Schutzrohr 23/28)		50 m/Rolle			1,40																																																																																																					
25 mm (Schutzrohr 28/34)		25 m/Rolle			1,60																																																																																																					
32 mm (Schutzrohr 36/42)		25 m/Rolle			2,30																																																																																																					

RIS

RIS

Roth Fittings PressCheck®

Preisgruppe RIS

Artikel	Artikelbeschreibung	Heizung ◆	Sanitär ●	Material-Nr.	Preis €uro
	<p>Roth T-Stück KU-Pressfitting, hergestellt aus dem Hochleistungskunststoff PPSU und MS-Pressfitting aus Messing. T-Stück mit Stützkörper und jeweils drei fixierten Edelstahl-Hülsen für die unlösbaren Verbindungen mit den Roth Systemrohren Alu-Laserplus®.</p>				
	Dimension			Verpackungseinheit	€/Stück
	T-Stücke				
	14 mm x 14 mm x 14 mm	KU		10 Stück	9,80
	17 mm x 17 mm x 17 mm	KU		10 Stück	7,90
	20 mm x 20 mm x 20 mm	KU		10 Stück	9,40
	25 mm x 25 mm x 25 mm	KU		5 Stück	14,80
	32 mm x 32 mm x 32 mm	KU		5 Stück	21,10
	40 mm x 40 mm x 40 mm	KU		2 Stück	45,00
	50 mm x 50 mm x 50 mm	KU		2 Stück	72,20
	63 mm x 63 mm x 63 mm	MS		1 Stück	130,80
	T-Stücke im Abgang reduziert				
	17 mm x 14 mm x 17 mm	KU		10 Stück	10,70
	20 mm x 14 mm x 20 mm	KU		10 Stück	11,90
	20 mm x 17 mm x 20 mm	KU		10 Stück	11,20
	25 mm x 17 mm x 25 mm	KU		10 Stück	14,10
	25 mm x 20 mm x 25 mm	KU		5 Stück	15,10
	32 mm x 20 mm x 32 mm	KU		5 Stück	22,50
	32 mm x 25 mm x 32 mm	KU		5 Stück	23,40
	40 mm x 20 mm x 40 mm	KU		2 Stück	32,20
	40 mm x 25 mm x 40 mm	KU		2 Stück	34,50
	40 mm x 32 mm x 40 mm	KU		2 Stück	36,90
	50 mm x 20 mm x 50 mm	MS		2 Stück	74,40
	50 mm x 25 mm x 50 mm	MS		2 Stück	77,20
	50 mm x 32 mm x 50 mm	MS		2 Stück	78,40
	50 mm x 40 mm x 50 mm	KU		2 Stück	67,50
	63 mm x 25 mm x 63 mm	MS		1 Stück	122,30
	63 mm x 32 mm x 63 mm	MS		1 Stück	122,50
	63 mm x 40 mm x 63 mm	MS		1 Stück	124,50
	63 mm x 50 mm x 63 mm	MS		1 Stück	132,40
	T-Stücke im Durchgang reduziert				
	17 mm x 17 mm x 14 mm	KU		10 Stück	11,80
	20 mm x 20 mm x 17 mm	KU		10 Stück	11,20
	25 mm x 25 mm x 20 mm	KU		5 Stück	17,00
	T-Stücke im Abgang und Durchgang reduziert				
	17 mm x 14 mm x 14 mm	KU		10 Stück	10,70
	20 mm x 17 mm x 17 mm	KU		10 Stück	10,80
	25 mm x 17 mm x 17 mm	KU		5 Stück	13,10
	25 mm x 17 mm x 20 mm	KU		5 Stück	14,80
	25 mm x 20 mm x 20 mm	KU		5 Stück	15,60
	32 mm x 20 mm x 20 mm	KU		5 Stück	20,20
	32 mm x 20 mm x 25 mm	KU		5 Stück	20,90
	32 mm x 25 mm x 25 mm	KU		5 Stück	21,70
	40 mm x 32 mm x 32 mm	MS		2 Stück	60,90
	63 mm x 50 mm x 50 mm	MS		1 Stück	132,40
	T-Stücke im Abgang erweitert				
	17 mm x 20 mm x 17 mm	KU		10 Stück	10,90
	20 mm x 25 mm x 17 mm	KU		5 Stück	15,60
	20 mm x 25 mm x 20 mm	KU		5 Stück	16,40
	20 mm x 32 mm x 20 mm	KU		5 Stück	20,30
	25 mm x 32 mm x 25 mm	KU		5 Stück	21,70



RIS Roth Fittings PressCheck® Preisgruppe RIS

Artikel Artikelbeschreibung Heizung Sanitär Material-Nr. Preis €uro



Roth Kupplung

KU-Pressfitting, hergestellt aus dem Hochleistungskunststoff **PPSU** und **MS-Pressfitting** aus **Messing**.
Kupplung mit Stützkörper und zwei fixierten Edelstahl-Hülsen für die unlösbaren Verbindungen mit den Roth Systemrohren Alu-Laserplus®.

Dimension	Verpackungseinheit	Heizung	Sanitär	Material-Nr.	Preis €uro
Kupplungen					
14 x 14 mm KU	10 Stück			1115005548	5,60
17 x 17 mm KU	10 Stück			1115005549	5,40
20 x 20 mm KU	10 Stück			1115005550	6,70
25 x 25 mm KU	10 Stück			1115005551	8,80
32 x 32 mm KU	5 Stück			1115005552	11,30
40 x 40 mm KU	2 Stück			1135004462	23,60
50 x 50 mm KU	2 Stück			1135004463	32,10
63 x 63 mm MS	1 Stück			1135004391	68,10

Kupplungen reduziert

17 x 14 mm KU	10 Stück			1115005553	6,00
20 x 14 mm KU	10 Stück			1115005554	7,30
20 x 17 mm KU	10 Stück			1115005555	6,80
25 x 17 mm KU	5 Stück			1135004465	7,90
25 x 20 mm KU	5 Stück			1115005556	8,60
32 x 20 mm KU	5 Stück			1135004466	9,50
32 x 25 mm KU	5 Stück			1115005557	12,40
40 x 25 mm MS	2 Stück			1135004392	26,80
40 x 32 mm KU	2 Stück			1135004467	25,40
50 x 32 mm MS	2 Stück			1135004395	36,40
50 x 40 mm KU	2 Stück			1135004468	33,70
63 x 40 mm MS	1 Stück			1135004396	68,70
63 x 50 mm MS	1 Stück			1135004397	68,70



Roth Winkel 90°

KU-Pressfitting, hergestellt aus dem Hochleistungskunststoff **PPSU** und **MS-Pressfitting** aus **Messing**.
Winkel 90° mit Stützkörper und jeweils zwei fixierten Edelstahl-Hülsen für die unlösbaren Verbindungen mit den Roth Systemrohren Alu-Laserplus®.

Dimension	Verpackungseinheit	Heizung	Sanitär	Material-Nr.	Preis €uro
Winkel 90°					
14 mm x 14 mm KU	10 Stück			1115005558	6,30
17 mm x 17 mm KU	10 Stück			1115005559	5,60
20 mm x 20 mm KU	10 Stück			1115005560	7,60
25 mm x 25 mm KU	10 Stück			1115005561	10,60
32 mm x 32 mm KU	10 Stück			1115005562	13,90
40 mm x 40 mm KU	2 Stück			1135004469	25,70
50 mm x 50 mm KU	2 Stück			1135004470	32,20
63 mm x 63 mm MS	1 Stück			1135004398	99,90



Roth Winkel 45°

KU-Pressfitting, hergestellt aus dem Hochleistungskunststoff **PPSU** und **MS-Pressfitting** aus **Messing**.
Winkel 45° mit Stützkörper und jeweils zwei fixierten Edelstahl-Hülsen für die unlösbaren Verbindungen mit den Roth Systemrohren Alu-Laserplus®.





Dimension	Verpackungseinheit	Heizung	Sanitär	Material-Nr.	Preis €uro
Winkel 45°					
25 mm x 25 mm KU	10 Stück			1115005563	13,20
32 mm x 32 mm KU	10 Stück			1115005564	16,10
40 mm x 40 mm KU	2 Stück			1135004471	26,90
50 mm x 50 mm MS	2 Stück			1135004399	60,30
63 mm x 63 mm MS	1 Stück			1135004400	101,80

RIS

RIS

Roth Fittings PressCheck®

Preisgruppe RIS

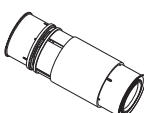
Artikel	Artikelbeschreibung	Heizung ◆	Sanitär ●	Material-Nr.	Preis €uro
	Roth Übergangsmuffe Mit Stützkörper und einer fixierten Edelstahl-Hülse. Mit Innengewindeübergang vom Roth Systemrohr Alu-Laserplus® auf Außengewinde.				
	Dimension			Verpackungseinheit	€/Stück
	14 mm x 1/2" IG	MS	◆	10 Stück	1115006700 11,30
	17 mm x 1/2" IG	MS	◆	10 Stück	1135000534 7,80
	20 mm x 1/2" IG	MS	◆	10 Stück	1135000536 9,80
	17 mm x 3/4" IG	MS	◆	10 Stück	1135000535 10,80
	20 mm x 3/4" IG	MS	◆	10 Stück	1135000537 10,80
	25 mm x 3/4" IG	MS	◆	5 Stück	1135001268 14,50
	25 mm x 1" IG	MS	◆	5 Stück	1135001269 18,50
	32 mm x 1" IG	MS	◆	5 Stück	1135001270 19,50
	32 mm x 1 1/4" IG	MS	◆	5 Stück	1135001271 23,90
	40 mm x 1 1/4" IG	MS	◆	2 Stück	1135004401 33,60
	40 mm x 1 1/2" IG	MS	◆	2 Stück	1135004402 33,60
	50 mm x 1 1/2" IG	MS	◆	2 Stück	1135004403 41,20
	63 mm x 2" IG	MS	◆	1 Stück	1135004404 70,00
	Roth Übergangsnippel Übergangsstück einseitig Gewinde, Rohranschluss mit festem Stützkörper und einer fixierten Edelstahl-Hülse für unlösbare Verbindungen mit den Roth Systemrohren Alu-Laserplus®.				
	Dimension			Verpackungseinheit	€/Stück
	14 mm x 1/2" AG	MS	◆	10 Stück	1135001383 8,10
	14 mm x 3/4" AG	MS	◆	10 Stück	1135001384 9,70
	17 mm x 1/2" AG	MS	◆	10 Stück	1135000530 6,40
	20 mm x 1/2" AG	MS	◆	10 Stück	1135000532 8,40
	17 mm x 3/4" AG	MS	◆	10 Stück	1135000531 8,30
	20 mm x 3/4" AG	MS	◆	10 Stück	1135000533 7,90
	25 mm x 3/4" AG	MS	◆	10 Stück	1135001272 12,70
	25 mm x 1" AG	MS	◆	10 Stück	1135001273 14,50
	32 mm x 1" AG	MS	◆	5 Stück	1135001274 16,60
	32 mm x 1 1/4" AG	MS	◆	5 Stück	1135001275 20,50
	40 mm x 1 1/4" AG	MS	◆	2 Stück	1135004405 28,70
	50 mm x 1 1/2" AG	MS	◆	2 Stück	1135004406 47,90
	63 mm x 2" AG	MS	◆	1 Stück	1135004407 66,30
	Roth Pressübergang Für den Anschluss des Roth Systemrohres Alu-Laserplus® an Rohrleitungen aus Kupfer oder Edelstahl mittels Verpressung, einschl. einer Edelstahl-Presshülse.				
	Dimension			Verpackungseinheit	€/Stück
	14 mm x ø 15 mm	RG	◆	10 Stück	1135001703 10,70
	17 mm x ø 15 mm	RG	◆	10 Stück	1135000545 10,70
	17 mm x ø 18 mm	RG	◆	10 Stück	1135000546 12,00
	20 mm x ø 18 mm	RG	◆	10 Stück	1135000547 12,60
	20 mm x ø 22 mm	RG	◆	10 Stück	1135000548 14,20
	25 mm x ø 22 mm	RG	◆	5 Stück	1135001264 15,70
	32 mm x ø 28 mm	RG	◆	5 Stück	1115006922 25,10
Hinweis: Für die Verpressung am metallrohrseitigen Anschluss (15, 18, 22, 28 mm) des Roth RG-Pressübergangs können auf die Fittingkontur abgestimmte, von Roth freigegebene Pressbacken eingesetzt werden. Die Verpressung für den Anschluss des Roth Systemrohres Alu-Laserplus® erfolgt mit den zum System Roth gehörenden Pressbacken.					
	Roth Reparaturfitting Bestehend aus einem RG-Doppelstützkörper und Edelstahl-Hülsen, für den Einbau im Reparaturfall in Alu-Laserplus® Rohrsträngen.				
	Dimension			Verpackungseinheit	€/Stück
	17 mm	RG	◆	1 Stück	1115005876 57,00
	20 mm	RG	◆	1 Stück	1115005877 59,50
	25 mm	RG	◆	1 Stück	1115005855 61,90
32 mm	RG	◆	1 Stück	1115005854 69,20	
	Roth Reparaturfitting Bestehend aus MS mit einer Edelstahl-Hülse, für den Einbau im Reparaturfall in Alu-Laserplus® Rohrsträngen.				
	Dimension			Verpackungseinheit	€/Stück
	40 mm	MS	◆	1 Stück	1135006360 311,00
	50 mm	MS	◆	1 Stück	1135006361 336,50
63 mm	MS	◆	1 Stück	1135006362 470,00	

RIS

RIS Roth Fittings PressCheck® Preisgruppe RIS

Artikel	Artikelbeschreibung	Heizung ◆	Sanitär ●	Material-Nr.	Preis €uro	
	Roth Übergangswinkel IG Mit Innengewindeübergang vom Roth Systemrohr Alu-Laserplus® auf Außengewinde, Rohranschluss mit festem Stützkörper und einer fixierten Edelstahl-Hülse.				€uro/Stück	
	Dimension			Verpackungseinheit		
	17 mm x 1/2" IG	MS	◆	●	10 Stück	1135000492 11,10
	20 mm x 1/2" IG	MS	◆	●	10 Stück	1135000494 16,60
	17 mm x 3/4" IG	MS	◆	●	10 Stück	1135000493 16,40
	20 mm x 3/4" IG	MS	◆	●	10 Stück	1135000495 17,50
	25 mm x 3/4" IG	MS	◆	●	5 Stück	1135001244 21,10
	25 mm x 1" IG	MS	◆	●	5 Stück	1135001245 24,60
	32 mm x 1" IG	MS	◆	●	5 Stück	1135001246 29,10
	32 mm x 1 1/4" IG	MS	◆	●	5 Stück	1135001247 30,70
	40 mm x 1 1/2" IG	MS	◆	●	2 Stück	1135004410 53,60
	50 mm x 1 1/2" IG	MS	◆	●	2 Stück	1135004411 67,00
	Roth Übergangswinkel AG Mit Außengewindeübergang vom Roth Systemrohr Alu-Laserplus® auf Innengewinde, Rohranschluss mit festem Stützkörper und einer Edelstahl-Hülse.				€uro/Stück	
	Dimension			Verpackungseinheit		
	14 mm x 3/8" AG*	RG	◆		10 Stück	1135001490 16,90
	14 mm x 1/2" AG	MS	◆		10 Stück	1135001491 15,60
	17 mm x 1/2" AG	MS	◆	●	10 Stück	1135000488 10,50
	20 mm x 1/2" AG	MS	◆	●	10 Stück	1135000490 14,60
	17 mm x 3/4" AG	MS	◆	●	10 Stück	1135000489 16,40
	20 mm x 3/4" AG	MS	◆	●	10 Stück	1135000491 17,90
	25 mm x 3/4" AG	MS	◆	●	5 Stück	1135001240 20,30
	25 mm x 1" AG	MS	◆	●	5 Stück	1135001241 23,70
	32 mm x 1" AG	MS	◆	●	5 Stück	1135001242 28,60
	32 mm x 1 1/4" AG	MS	◆	●	5 Stück	1135001243 30,20
	40 mm x 1 1/4" AG	MS	◆	●	2 Stück	1135004408 50,70
50 mm x 1 1/2" AG	MS	◆	●	2 Stück	1135004409 66,10	
	Roth Wandscheibe Mit Stützkörper und einer Edelstahl-Hülse, für die Fixierung der Anschlusspunkte. Das Roth Schallschutzset ist separat zu bestellen.				€uro/Stück	
	Dimension			Verpackungseinheit		
	14 mm x 1/2" IG	MS		●	10 Stück	1135001378 15,30
	17 mm x 1/2" IG	MS		●	10 Stück	1135000512 11,10
	20 mm x 1/2" IG	MS		●	10 Stück	1135000513 14,60
	20 mm x 3/4" IG	MS		●	5 Stück	1135001492 18,40
25 mm x 3/4" IG	MS		●	5 Stück	1135001230 25,60	
	Roth Schallschutzset Aus EPDM für die Aufnahme der Roth-MS-Wandscheiben zur Schallentkopplung. Bestehend aus Fußelement für 3-Loch-Flansch der Wandscheibe und Abdeckhaube.				€uro/Stück	
	Dimension			Verpackungseinheit		
14-20 mm			●	5 Stück	1135005457 7,90	
	Roth Wandscheibe Durchgang Mit Stützkörper und zwei Edelstahl-Hülsen, zum Anschluss einer Entnahmestelle und zur Weiterführung der Rohrleitung zum nächsten Anschlusspunkt. Eine Roth Schutzkappe inkl. Roth Schalldämmplatte sind separat zu bestellen.				€uro/Stück	
	Dimension			Verpackungseinheit		
	17 mm x 1/2" IG x 17 mm	MS		●	10 Stück	1135001701 26,10
	20 mm x 1/2" IG x 20 mm	MS		●	10 Stück	1135001702 28,10
	Roth U-Wandscheibe Mit Stützkörper und zwei Edelstahl-Hülsen, zum Anschluss einer Entnahmestelle und zur Weiterführung der Rohrleitung zum nächsten Anschlusspunkt.				€uro/Stück	
	Dimension			Verpackungseinheit		
	17 mm x 1/2" IG x 17 mm	MS		●	10 Stück	1135004534 33,70
	20 mm x 1/2" IG x 20 mm	MS		●	10 Stück	1135004535 37,20
	20 mm x 1/2" IG x 17 mm	MS		●	10 Stück	1135004537 37,20
	Roth Schallschutzset U-Wandscheibe Aus EPDM für die Aufnahme der Roth U-Wandscheiben zur Schallentkopplung. Bestehend aus Fußelement und Abdeckhaube.				€uro/Stück	
	Dimension			Verpackungseinheit		
	17-20 mm			●	5 Stück	NEU 1135006191 13,60

RIS

Roth Fittings PressCheck®

Preisgruppe RIS

Artikel	Artikelbeschreibung	Heizung ◆	Sanitär ●	Material-Nr.	Preis €uro
	Roth Wandscheibe 90° Aus Rotguss , mit Stützkörper und zwei Edelstahl-Hülsen, zum Anschluss einer Entnahmestelle und zur Weiterführung der Rohrleitung zum nächsten Anschlusspunkt. Eine Roth Schutzkappe inkl. Roth Schalldämmplatte sind separat zu bestellen.				
	Dimension Verpackungseinheit 17 mm x 1/2" IG x 17 mm* RG 10 Stück		●	1135000514	25,50
	20 mm x 1/2" IG x 20 mm* RG 10 Stück		●	1135000515	27,50
	20 mm x 1/2" IG x 17 mm* RG 10 Stück		●	1135000516	24,60
	Roth Wandscheibenset Typ E* Bestehend aus zwei auf einem verzinkten Stahlblech vormontierten Roth Wandscheiben aus Messing mit Edelstahl-Hülsen.				
	Dimension Stichmaß Verpackungseinheit 17 mm x 1/2" IG MS* 153 mm 1 Stück*		●	1115005020	28,60
	20 mm x 1/2" IG MS* 153 mm 1 Stück*		●	1115005021	35,80
	Roth Wandscheibenset Typ F & D* Bestehend aus zwei, auf einem verzinkten Stahlblech vormontierten Roth Wandscheiben aus Messing , mit Edelstahl-Hülsen.				
	Dimension Stichmaß Verpackungseinheit 17 mm x 1/2" IG MS* 80 mm Typ F 1 Stück*		●	1115006492	28,60
	17 mm x 1/2" IG MS* 153 mm Typ D 1 Stück*		●	1115006493	35,80
	Roth Wandscheibenset Typ A/SE (153) Bestehend aus einem formstabilen, mit Sicken verstärkten, verzinkten Stahlblech. Die Roth Wandscheiben aus Messing mit Edelstahl-Hülse sind werkseitig zentriert vormontiert und zur Schallentkopplung zusätzlich mit dem Schallschutzset versehen.				
	Dimension Stichmaß Verpackungseinheit			NEU	€uro/Stück
	17 mm x 1/2" IG MS 153 mm 1 Stück		●	1135006226	35,80
	Roth Wandscheibenset Typ I/SE (100/153) Bestehend aus einem formstabilen, mit Sicken verstärkten, verzinkten Stahlblech. Die Roth Wandscheiben aus Messing mit Edelstahl-Hülse sind werkseitig zentriert vormontiert und zur Schallentkopplung zusätzlich mit dem Schallschutzset versehen. Optionale Möglichkeit der bauseitigen Montage des Roth Ablaufschellensets vorhanden.				
	Dimension Stichmaß Verpackungseinheit			NEU	€uro/Stück
	17 mm x 1/2" IG MS 153 mm 1 Stück		●	1135006228	35,80
	Roth Wandscheibenset Typ I/SE (80) Bestehend aus einem formstabilen, verzinkten Stahlblech. Die Roth Wandscheiben aus Messing mit Edelstahl-Hülse sind werkseitig zentriert vormontiert und zur Schallentkopplung zusätzlich mit dem Schallschutzset versehen. Optionale Möglichkeit der bauseitigen Montage des Roth Ablaufschellensets vorhanden.				
	Dimension Stichmaß Verpackungseinheit			NEU	€uro/Stück
	17 mm x 1/2" IG MS 80 mm 1 Stück		●	1135006231	35,80
	Roth Wanddurchführung Mit Stützkörper und einer Edelstahl-Hülse, für die Trockenbauweise, einschl. Dichtscheiben und Befestigungselement mit 3/4" IG.				
	Dimension Verpackungseinheit				€uro/Stück
	17 mm x 1/2" IG (3/4" AG) MS 10 Stück		●	1135000507	26,10
20 mm x 1/2" IG (3/4" AG) MS 10 Stück		●	1135000508	27,10	



RIS Roth Fittings PressCheck® Preisgruppe RIS

Artikel	Artikelbeschreibung	Heizung ◆	Sanitär ●	Material-Nr.	Preis €uro	
	Roth T-Stück mit IG Mit Stützkörper und zwei fixierten Edelstahl-Hülsen, Innengewinde-Anschluss für den Übergang auf Außengewinde.				€uro/Stück	
	Dimension	Verpackungseinheit				
	17 mm x 1/2" IG x 17 mm MS	10 Stück	◆	●	1135001131	20,60
	20 mm x 1/2" IG x 20 mm MS	10 Stück	◆	●	1135001132	20,60
	17 mm x 3/4" IG x 17 mm MS	10 Stück	◆	●	1135001133	22,20
	20 mm x 3/4" IG x 20 mm MS	10 Stück	◆	●	1135001134	22,20
	25 mm x 1/2" IG x 25 mm MS	5 Stück	◆	●	1115005692	25,60
	25 mm x 3/4" IG x 25 mm MS	5 Stück	◆	●	1135004506	29,60
	32 mm x 1/2" IG x 32 mm MS	5 Stück	◆	●	1115005693	34,20
	32 mm x 3/4" IG x 32 mm MS	5 Stück	◆	●	1135004507	38,00
	40 mm x 3/4" IG x 40 mm MS	2 Stück	◆	●	1135004421	60,10
	40 mm x 1" IG x 40 mm MS	2 Stück	◆	●	1135004422	61,90
	50 mm x 1" IG x 50 mm MS	2 Stück	◆	●	1135004423	65,70
	63 mm x 1" IG x 63 mm MS	1 Stück	◆	●	1135004424	121,70
	Roth Anschlusswinkel mit IG und AG Aus Messing, mit Stützkörper und einer Edelstahl-Hülse, zur Wanddurchführung und dem vereinfachten Anschluss von UP-Geräten und -Batterien, einschl. Dichtscheibe und Befestigungselement mit 3/4" IG.				€uro/Stück	
	Dimension	Verpackungseinheit				
	14 mm x 1/2" IG (3/4" AG) MS	10 Stück		●	1135001489	20,90
	17 mm x 1/2" IG (3/4" AG) MS	10 Stück		●	1135001392	21,50
	20 mm x 1/2" IG (3/4" AG) MS	10 Stück		●	1135001393	22,90
	Roth Anschlusswinkel TB Aus Messing, mit Stützkörper und einer Edelstahl-Hülse für den vereinfachten Wandanschluss in der Trockenbauweise von UP-Geräten und -Batterien, einschließlich Dichtscheibe und Befestigungselement mit 3/4" IG.				€uro/Stück	
	Dimension	Verpackungseinheit				
	17 mm x 1/2" IG (3/4" AG) MS	10 Stück		●	1115006153	26,10
	Roth T-Stück TB* Aus Rotguss, mit Stützkörpern und zwei Edelstahl-Hülsen für den vereinfachten Wandanschluss in der Trockenbauweise von UP-Geräten und -Batterien und zur Weiterführung zum nächsten Anschlusspunkt, einschließlich Dichtscheibe und Befestigungselement mit 3/4" IG.				€uro/Stück	
	Dimension	Verpackungseinheit				
	17 mm x 1/2" IG (3/4" AG) x 17 mm* RG	10 Stück		●	1115006154	35,40
	20 mm x 1/2" IG (3/4" AG) x 20 mm* RG	10 Stück		●	1115006155	36,00
	Roth Geräteverschraubung Aus Messing, inkl. Edelstahl-Hülse, mit Pressanschluss und Überwurf-Verschraubung mit Flachdichtung. Der Verschraubungskörper wahlweise mit IG oder AG für lösbare Geräteanschlüsse.				€uro/Stück	
	Dimension	Verpackungseinheit				
	20 mm x 3/4" AG MS	10 Stück		●	1115005389	20,60
	20 mm x 1" AG MS	10 Stück		●	1115005391	23,70
	25 mm x 1" AG MS	5 Stück		●	1115005395	24,10
	32 mm x 1 1/4" AG MS	5 Stück		●	1115005397	32,20
	32 mm x 1" AG MS	5 Stück		●	1115005399	32,20
	20 mm x 3/4" IG MS	10 Stück		●	1115005390	19,70
	20 mm x 1" IG MS	10 Stück		●	1115005394	25,60
	25 mm x 1" IG MS	5 Stück		●	1115005396	26,50
	32 mm x 1 1/4" IG MS	5 Stück		●	1115005398	36,50
	32 mm x 1" IG MS	5 Stück		●	1115005400	28,60
	Roth Verteiler TW* Warm- bzw. Kaltwasserverteiler aus Rotguss mit 1" IG/AG, als Einheit mit 2 oder 3 Anschlussstutzen 3/4" AG zum Anschluss der Roth Systemrohre Alu-Laserplus®. Die Verteilereinheiten sind kombinierbar. Die Verteiler sind im Karton verpackt. Zum Lieferumfang gehören ein Satz Bezeichnungsschilder zur Kennzeichnung der Objektanschlüsse und eine Blindkappe 1" IG.				€uro/Stück	
	Verteiler	L ges. in mm	Verpackungseinheit			
	RG-TW 2	121	1 Stück	●	1135001495	31,90
	RG-TW 3	176	1 Stück	●	1135001496	40,90

RIS

RIS





Roth Systemkomponenten

Preisgruppe RIS

Artikel	Artikelbeschreibung	Heizung ◆	Sanitär ●	Material-Nr.	Preis €uro																																																																																																										
	<p>Roth Verteilerhalterung TW* Aus verzinktem Stahlblech, für die Befestigung der Roth Warm- und Kaltwasserverteiler RG-TW. Die Verteilerstämme lassen sich in der Tiefe versetzt zueinander montieren. Die Verteileraufnahme ist mit einer Schalldämmeinlage versehen.</p> <p>Verpackungseinheit 1 Stück</p>		●	1135001494	€uro/Stück 12,10																																																																																																										
	<p>Roth Pressverschraubung Für den Anschluss des Roth Systemrohres Alu-Laserplus® an den Roth HK-Verteiler bzw. Roth RG-Verteiler TW. Bestehend aus Messing-Überwurfmutter IG 3/4", MS Stützkörper mit Eurokonus und Edelstahl-Hülse.</p> <p>Dimension</p> <table border="0"> <tr> <td>14 mm</td> <td>MS</td> <td>Verpackungseinheit</td> <td>10 Stück</td> <td>◆</td> <td>●</td> <td>1135001503</td> <td>€uro/Stück</td> <td>7,40</td> </tr> <tr> <td>17 mm</td> <td>MS</td> <td>10 Stück</td> <td>◆</td> <td>●</td> <td>1135001505</td> <td>€uro/Stück</td> <td>7,60</td> </tr> <tr> <td>20 mm</td> <td>MS</td> <td>10 Stück</td> <td>◆</td> <td>●</td> <td>1135001506</td> <td>€uro/Stück</td> <td>7,60</td> </tr> </table>	14 mm	MS	Verpackungseinheit	10 Stück	◆	●	1135001503	€uro/Stück	7,40	17 mm	MS	10 Stück	◆	●	1135001505	€uro/Stück	7,60	20 mm	MS	10 Stück	◆	●	1135001506	€uro/Stück	7,60																																																																																					
14 mm	MS	Verpackungseinheit	10 Stück	◆	●	1135001503	€uro/Stück	7,40																																																																																																							
17 mm	MS	10 Stück	◆	●	1135001505	€uro/Stück	7,60																																																																																																								
20 mm	MS	10 Stück	◆	●	1135001506	€uro/Stück	7,60																																																																																																								
	<p>Roth Blindkappe Zum Verschließen von nicht benötigten Anschlüssen am Roth HK-Verteiler bzw. Roth RG-Verteiler TW.</p> <p>Dimension</p> <table border="0"> <tr> <td>IG 3/4"</td> <td></td> <td>Verpackungseinheit</td> <td>10 Stück</td> <td>◆</td> <td>●</td> <td>1135000354</td> <td>€uro/Stück</td> <td>4,30</td> </tr> </table>	IG 3/4"		Verpackungseinheit	10 Stück	◆	●	1135000354	€uro/Stück	4,30																																																																																																					
IG 3/4"		Verpackungseinheit	10 Stück	◆	●	1135000354	€uro/Stück	4,30																																																																																																							
	<p>Roth Anschlussverschraubung Inkl. Stützkörper und Flachdichtung, mit Pressanschluss und Überwurf-Verschraubung. Der Verschraubungskörper mit IG für lösbare Anschlüsse.</p> <p>Dimension</p> <table border="0"> <tr> <td>17 mm x 1/2" IG</td> <td>MS</td> <td>Verpackungseinheit</td> <td>10 Stück</td> <td>◆</td> <td>●</td> <td>1135000517</td> <td>€uro/Stück</td> <td>9,10</td> </tr> <tr> <td>17 mm x 3/4" IG</td> <td>MS</td> <td>10 Stück</td> <td>◆</td> <td>●</td> <td>1135000518</td> <td>€uro/Stück</td> <td>9,10</td> </tr> <tr> <td>20 mm x 3/4" IG</td> <td>MS</td> <td>10 Stück</td> <td>◆</td> <td>●</td> <td>1135000519</td> <td>€uro/Stück</td> <td>9,30</td> </tr> <tr> <td>20 mm x 1" IG</td> <td>MS</td> <td>10 Stück</td> <td>◆</td> <td>●</td> <td>1135000520</td> <td>€uro/Stück</td> <td>11,20</td> </tr> <tr> <td>25 mm x 3/4" IG</td> <td>MS</td> <td>5 Stück</td> <td>◆</td> <td>●</td> <td>1115006163</td> <td>€uro/Stück</td> <td>13,60</td> </tr> <tr> <td>25 mm x 1" IG</td> <td>MS</td> <td>5 Stück</td> <td>◆</td> <td>●</td> <td>1135001276</td> <td>€uro/Stück</td> <td>13,60</td> </tr> <tr> <td>32 mm x 1 1/4" IG</td> <td>MS</td> <td>5 Stück</td> <td>◆</td> <td>●</td> <td>1135001277</td> <td>€uro/Stück</td> <td>16,40</td> </tr> <tr> <td>40 mm x 1 1/2" IG</td> <td>MS</td> <td>2 Stück</td> <td>◆</td> <td>●</td> <td>1135004412</td> <td>€uro/Stück</td> <td>32,30</td> </tr> <tr> <td>40 mm x 1 3/4" IG</td> <td>MS</td> <td>2 Stück</td> <td>◆</td> <td>●</td> <td>1135004413</td> <td>€uro/Stück</td> <td>33,70</td> </tr> <tr> <td>50 mm x 1 1/2" IG</td> <td>MS</td> <td>2 Stück</td> <td>◆</td> <td>●</td> <td>1135004414</td> <td>€uro/Stück</td> <td>43,90</td> </tr> <tr> <td>50 mm x 1 3/4" IG</td> <td>MS</td> <td>2 Stück</td> <td>◆</td> <td>●</td> <td>1135004415</td> <td>€uro/Stück</td> <td>74,40</td> </tr> <tr> <td>50 mm x 2" IG</td> <td>MS</td> <td>2 Stück</td> <td>◆</td> <td>●</td> <td>1135004416</td> <td>€uro/Stück</td> <td>64,40</td> </tr> <tr> <td>63 mm x 2 3/8" IG</td> <td>MS</td> <td>1 Stück</td> <td>◆</td> <td>●</td> <td>1135004417</td> <td>€uro/Stück</td> <td>92,60</td> </tr> </table>	17 mm x 1/2" IG	MS	Verpackungseinheit	10 Stück	◆	●	1135000517	€uro/Stück	9,10	17 mm x 3/4" IG	MS	10 Stück	◆	●	1135000518	€uro/Stück	9,10	20 mm x 3/4" IG	MS	10 Stück	◆	●	1135000519	€uro/Stück	9,30	20 mm x 1" IG	MS	10 Stück	◆	●	1135000520	€uro/Stück	11,20	25 mm x 3/4" IG	MS	5 Stück	◆	●	1115006163	€uro/Stück	13,60	25 mm x 1" IG	MS	5 Stück	◆	●	1135001276	€uro/Stück	13,60	32 mm x 1 1/4" IG	MS	5 Stück	◆	●	1135001277	€uro/Stück	16,40	40 mm x 1 1/2" IG	MS	2 Stück	◆	●	1135004412	€uro/Stück	32,30	40 mm x 1 3/4" IG	MS	2 Stück	◆	●	1135004413	€uro/Stück	33,70	50 mm x 1 1/2" IG	MS	2 Stück	◆	●	1135004414	€uro/Stück	43,90	50 mm x 1 3/4" IG	MS	2 Stück	◆	●	1135004415	€uro/Stück	74,40	50 mm x 2" IG	MS	2 Stück	◆	●	1135004416	€uro/Stück	64,40	63 mm x 2 3/8" IG	MS	1 Stück	◆	●	1135004417	€uro/Stück	92,60					
17 mm x 1/2" IG	MS	Verpackungseinheit	10 Stück	◆	●	1135000517	€uro/Stück	9,10																																																																																																							
17 mm x 3/4" IG	MS	10 Stück	◆	●	1135000518	€uro/Stück	9,10																																																																																																								
20 mm x 3/4" IG	MS	10 Stück	◆	●	1135000519	€uro/Stück	9,30																																																																																																								
20 mm x 1" IG	MS	10 Stück	◆	●	1135000520	€uro/Stück	11,20																																																																																																								
25 mm x 3/4" IG	MS	5 Stück	◆	●	1115006163	€uro/Stück	13,60																																																																																																								
25 mm x 1" IG	MS	5 Stück	◆	●	1135001276	€uro/Stück	13,60																																																																																																								
32 mm x 1 1/4" IG	MS	5 Stück	◆	●	1135001277	€uro/Stück	16,40																																																																																																								
40 mm x 1 1/2" IG	MS	2 Stück	◆	●	1135004412	€uro/Stück	32,30																																																																																																								
40 mm x 1 3/4" IG	MS	2 Stück	◆	●	1135004413	€uro/Stück	33,70																																																																																																								
50 mm x 1 1/2" IG	MS	2 Stück	◆	●	1135004414	€uro/Stück	43,90																																																																																																								
50 mm x 1 3/4" IG	MS	2 Stück	◆	●	1135004415	€uro/Stück	74,40																																																																																																								
50 mm x 2" IG	MS	2 Stück	◆	●	1135004416	€uro/Stück	64,40																																																																																																								
63 mm x 2 3/8" IG	MS	1 Stück	◆	●	1135004417	€uro/Stück	92,60																																																																																																								
	<p>Roth Abdrückstopfen Wiederverwendbare Abdrückstopfen inkl. Klemmringverschraubung zum Abdrücken des Roth Installationssystems.</p> <p>Dimension</p> <table border="0"> <tr> <td>14 mm</td> <td></td> <td>Verpackungseinheit</td> <td>1 Stück</td> <td>◆</td> <td>●</td> <td>1115006902</td> <td>€uro/Stück</td> <td>36,40</td> </tr> <tr> <td>17 mm</td> <td></td> <td>1 Stück</td> <td>◆</td> <td>●</td> <td>1115006903</td> <td>€uro/Stück</td> <td>35,40</td> </tr> <tr> <td>20 mm</td> <td></td> <td>1 Stück</td> <td>◆</td> <td>●</td> <td>1115006904</td> <td>€uro/Stück</td> <td>36,20</td> </tr> <tr> <td>25 mm</td> <td></td> <td>1 Stück</td> <td>◆</td> <td>●</td> <td>1115006905</td> <td>€uro/Stück</td> <td>44,00</td> </tr> <tr> <td>32 mm</td> <td></td> <td>1 Stück</td> <td>◆</td> <td>●</td> <td>1115006906</td> <td>€uro/Stück</td> <td>58,20</td> </tr> <tr> <td>40 mm</td> <td></td> <td>1 Stück</td> <td>◆</td> <td>●</td> <td>1135004445</td> <td>€uro/Stück</td> <td>78,70</td> </tr> <tr> <td>50 mm</td> <td></td> <td>1 Stück</td> <td>◆</td> <td>●</td> <td>1135004446</td> <td>€uro/Stück</td> <td>114,40</td> </tr> <tr> <td>63 mm</td> <td></td> <td>1 Stück</td> <td>◆</td> <td>●</td> <td>1115006909</td> <td>€uro/Stück</td> <td>135,50</td> </tr> </table>	14 mm		Verpackungseinheit	1 Stück	◆	●	1115006902	€uro/Stück	36,40	17 mm		1 Stück	◆	●	1115006903	€uro/Stück	35,40	20 mm		1 Stück	◆	●	1115006904	€uro/Stück	36,20	25 mm		1 Stück	◆	●	1115006905	€uro/Stück	44,00	32 mm		1 Stück	◆	●	1115006906	€uro/Stück	58,20	40 mm		1 Stück	◆	●	1135004445	€uro/Stück	78,70	50 mm		1 Stück	◆	●	1135004446	€uro/Stück	114,40	63 mm		1 Stück	◆	●	1115006909	€uro/Stück	135,50																																													
14 mm		Verpackungseinheit	1 Stück	◆	●	1115006902	€uro/Stück	36,40																																																																																																							
17 mm		1 Stück	◆	●	1115006903	€uro/Stück	35,40																																																																																																								
20 mm		1 Stück	◆	●	1115006904	€uro/Stück	36,20																																																																																																								
25 mm		1 Stück	◆	●	1115006905	€uro/Stück	44,00																																																																																																								
32 mm		1 Stück	◆	●	1115006906	€uro/Stück	58,20																																																																																																								
40 mm		1 Stück	◆	●	1135004445	€uro/Stück	78,70																																																																																																								
50 mm		1 Stück	◆	●	1135004446	€uro/Stück	114,40																																																																																																								
63 mm		1 Stück	◆	●	1115006909	€uro/Stück	135,50																																																																																																								
	<p>Roth Presshülse Ersatzhülse (Edelstahl) mit Kombiring.</p> <p>Dimension</p> <table border="0"> <tr> <td>14 mm</td> <td></td> <td>Verpackungseinheit</td> <td>10 Stück</td> <td>◆</td> <td>●</td> <td>1135000381</td> <td>€uro/Stück</td> <td>2,00</td> </tr> <tr> <td>17 mm</td> <td></td> <td>10 Stück</td> <td>◆</td> <td>●</td> <td>1135000382</td> <td>€uro/Stück</td> <td>2,10</td> </tr> <tr> <td>20 mm</td> <td></td> <td>10 Stück</td> <td>◆</td> <td>●</td> <td>1135000383</td> <td>€uro/Stück</td> <td>2,30</td> </tr> <tr> <td>25 mm</td> <td></td> <td>10 Stück</td> <td>◆</td> <td>●</td> <td>1135001368</td> <td>€uro/Stück</td> <td>2,50</td> </tr> <tr> <td>32 mm</td> <td></td> <td>10 Stück</td> <td>◆</td> <td>●</td> <td>1135001369</td> <td>€uro/Stück</td> <td>3,10</td> </tr> <tr> <td>40 mm</td> <td></td> <td>2 Stück</td> <td>◆</td> <td>●</td> <td>1135004538</td> <td>€uro/Stück</td> <td>4,20</td> </tr> <tr> <td>50 mm</td> <td></td> <td>2 Stück</td> <td>◆</td> <td>●</td> <td>1135004539</td> <td>€uro/Stück</td> <td>5,60</td> </tr> <tr> <td>63 mm</td> <td></td> <td>1 Stück</td> <td>◆</td> <td>●</td> <td>1135004540</td> <td>€uro/Stück</td> <td>8,30</td> </tr> </table>	14 mm		Verpackungseinheit	10 Stück	◆	●	1135000381	€uro/Stück	2,00	17 mm		10 Stück	◆	●	1135000382	€uro/Stück	2,10	20 mm		10 Stück	◆	●	1135000383	€uro/Stück	2,30	25 mm		10 Stück	◆	●	1135001368	€uro/Stück	2,50	32 mm		10 Stück	◆	●	1135001369	€uro/Stück	3,10	40 mm		2 Stück	◆	●	1135004538	€uro/Stück	4,20	50 mm		2 Stück	◆	●	1135004539	€uro/Stück	5,60	63 mm		1 Stück	◆	●	1135004540	€uro/Stück	8,30																																													
14 mm		Verpackungseinheit	10 Stück	◆	●	1135000381	€uro/Stück	2,00																																																																																																							
17 mm		10 Stück	◆	●	1135000382	€uro/Stück	2,10																																																																																																								
20 mm		10 Stück	◆	●	1135000383	€uro/Stück	2,30																																																																																																								
25 mm		10 Stück	◆	●	1135001368	€uro/Stück	2,50																																																																																																								
32 mm		10 Stück	◆	●	1135001369	€uro/Stück	3,10																																																																																																								
40 mm		2 Stück	◆	●	1135004538	€uro/Stück	4,20																																																																																																								
50 mm		2 Stück	◆	●	1135004539	€uro/Stück	5,60																																																																																																								
63 mm		1 Stück	◆	●	1135004540	€uro/Stück	8,30																																																																																																								



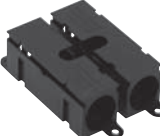





RIS Roth Systemkomponenten Preisgruppe RIS

Artikel	Artikelbeschreibung	Heizung ◆	Sanitär ●	Material-Nr.	Preis €uro
	Roth Heizkörper-Anschlusswinkel Zum Anschluss der Heizkörper über den Boden, die Wand oder die Decke. Bestehend aus: Messing-Anschlussstück mit Stützkörper, angelötetem Cu-Rohr, Durchmesser 15 mm, komplett vernickelt und einer Edelstahl-Hülse für eine unlösbare Verbindung mit den Roth Systemrohren Alu-Laserplus®.				
	Anschlusswinkel für Cu-Rohr Länge Verpackungseinheit				€/Stück
	14 mm 300 mm 2 Stück	◆		1135000394	15,00
	17 mm 300 mm 2 Stück	◆		1135000396	15,00
20 mm 300 mm 2 Stück	◆		1135001366	19,40	
	Roth Heizkörper-Anschluss-T-Stück Zum Anschluss der Heizkörper über den Boden. Bestehend aus: Messing-Anschluss-T-Stück mit Stützkörper, angelötetem Cu-Rohr, Durchmesser 15 mm, komplett vernickelt und zwei Edelstahl-Hülsen für eine unlösbare Verbindung mit den Roth Systemrohren Alu-Laserplus®.				
	Anschluss T-Stücke für Cu-Rohr Länge Verpackungseinheit				€/Stück
	14 mm 300 mm 2 Stück	◆		1135000398	20,10
	17 mm 300 mm 2 Stück	◆		1135000400	20,10
20 mm 300 mm 2 Stück	◆		1135000402	22,00	
	Roth Anschlussdose W Für die Aufnahme der Roth HK-Anschlusswinkel 14, 17 und 20 mm, zur Fixierung auf dem Boden und in der Wand. Bestehend aus einer Kunststoff-Anschlussdose mit Deckel und Distanzleiste.				
	Dimension Verpackungseinheit				€/Stück
	14 und 17 mm 2 Stück	◆		1135000277	2,10
20 mm 2 Stück	◆		1135001386	2,20	
	Roth Anschlussdose T Für die Aufnahme der Roth HK-Anschluss-T-Stücke 14, 17 und 20 mm, zur Fixierung auf dem Boden und in der Wand. Bestehend aus einer Kunststoff-Anschlussdose mit Deckel.				
	Dimension Verpackungseinheit				€/Stück
14, 17 und 20 mm 2 Stück	◆		1135001388	2,20	
	Roth Anschlussblock Für die montagefertige druckbelastete Ausführung von Heizkörperanschlüssen aus der Wandkonstruktion vor Beendigung von Putz- und Tapezier- bzw. Fliesenarbeiten. Bestehend aus PS-Montageblock einschließlich werkseitig vorgeformter Heizkörper-Rohranschlusseinheit aus Roth Systemrohr Alu-Laserplus® 14 mm bzw. 17 mm.				
	HK-Anschlussblock 14 mm Verpackungseinheit				€/Stück
	HK-Anschlussblock 17 mm 10 Stück	◆		1135002671	28,70
	HK-Anschlussblock 17 mm 10 Stück	◆		1135002672	28,70
	Gesamtbreite: 105 mm Gesamthöhe: 260 mm Gesamttiefe: 225 mm Gesamtmaterialstärke: 50 mm Ventilachsmaß: 50 mm				

RIS

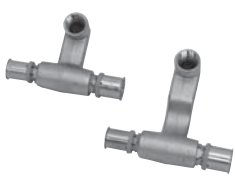
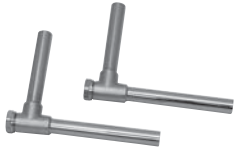
Roth Systemkomponenten

Preisgruppe RIS

Artikel	Artikelbeschreibung	Heizung ◆	Sanitär ●	Material-Nr.	Preis €uro
	<p>Roth Heizkörperanschlussset* Bestehend aus zwei auf einem verzinkten Stahlblech vormontierten Roth Wandscheiben aus Messing mit Edelstahl-Hülsen</p> <p>Dimension 17 mm x 1/2" IG MS Stichmaß 50 mm* Verpackungseinheit 1 Stück</p>	◆		1115007672	€uro/Stück 28,00
	<p>Roth Heizkörperanschlussblock mit Schutzrohr Für das nachträgliche Einziehen der Roth Systemrohre Alu-Laserplus® 14 und 17 mm zu den Heizkörperanschlüssen nach den Verputzarbeiten. Bestehend aus PU-Schaumblock inkl. PE-Schutzrohr 34/28.</p> <p>Gesamtbreite: 115 mm Gesamthöhe: 150 mm Gesamttiefe: 70 mm Ventilachsmaß: 50 mm</p>		◆	1135003234	€uro/Stück 27,30
	<p>Roth Rohrführungsbogen Zum direkten Anschluss der Roth Systemrohre an die Heizkörperventile. Farbe weiß</p> <p>Bestehend aus 2 Rohrführungsbogen mit Distanzstücken; 2 Klappmanschetten, anti-ultra-violett; 2 Sicherungskeile; 2 Stopfen</p>		◆	1135000442	€uro/Set 16,00
	<p>Roth Anschlusseinheit-Sockelleiste Set zum Anschluss eines Heizkörpers (Vor- und Rücklauf) aus der Sockelleiste. Das Set beinhaltet je ein kurzes und langes Anschlusselement aus einem vernickelten Gussformteil mit 1/2" IG, angeformten Stützkörpern und Edelstahl-Hülsen.</p>		◆		€uro/Set
	Dimension 17 mm/r - 1/2" IG	Verpackungseinheit 1 Set	◆	1135000462	55,00
	17mm /l - 1/2" IG	1 Set	◆	1135000459	55,00
	17 mm - 1/2" IG - 17	1 Set	◆	1135000455	62,60
	17mm - 1/2" IG - 20	1 Set	◆	1135001488	62,60
	20 mm - 1/2" IG - 17	1 Set	◆	1135000453	65,50
	20 mm - 1/2" IG - 20	1 Set	◆	1135000452	65,50
	<p>Roth Winkelabspernung Absperrbares Verbindungselement zwischen Roth Anschlusseinheit-Sockelleiste und Heizkörperanschluss mit 90° Richtungsänderung, Anschluss Cu-Rohr 15 mm vernickelt.</p>		◆	1135000464	€uro/Set 24,60
	<p>Roth Passbogen 90° 90° abgewinkeltes, vernickeltes Cu-Rohr, 15 mm, zum Anschluss des Heizkörpers an die Roth Anschlusseinheit-Sockelleiste.</p>		◆	1135000465	€uro/Set 11,40
	<p>Roth Klemmverschraubung 1/2" AG Aus vernickeltem Messing, zum Anschluss der Cu-Rohre 15 mm an die Roth Anschlusseinheit-Sockelleiste, inkl. Klemmring und Stützkörper.</p>		◆	1115001671	€uro/Stück 7,10
	<p>Roth Klemmverschraubung 3/4" IG Aus vernickeltem Messing, zum Anschluss der Roth HK-Anschlusswinkel und Roth HK-Anschluss-T-Stücke an Ventil-Fremdfabrikate sowie Hahnblöcken mit 3/4" AG bei Ventil-Kompaktheizkörpern, inkl. Klemmring und Stützkörper.</p>		◆	1115001672	€uro/Stück 11,20

RIS

RIS

Roth Systemkomponenten

Preisgruppe RIS

Artikel	Artikelbeschreibung	Heizung	Sanitär	Material-Nr.	Preis €uro																																																								
	<p>Roth Dübelhaken DD Zur schnellen, schonenden Fixierung parallel verlaufender Roth Systemrohre Alu-Laserplus® mit Wärmedämmung auf dem Rohboden, durch Einschlagen in Bohrlöcher mit 8 mm Durchmesser.</p> <p>Verpackungseinheit 50 Stück</p>			1135001311	€uro/Stück 0,82																																																								
	<p>Roth Rohrschellen einfach Zur Befestigung einzelner Roth Systemrohre Alu-Laserplus® auf der Rohdecke.</p> <table border="1"> <thead> <tr> <th>Rohrschellen-abmessung</th> <th>Rohrdimension ohne Schutzrohr</th> <th>Rohrdimension ohne Schutzrohr</th> <th>Verpackungseinheit mit Schutzrohr</th> <th>Heizung </th> <th>Sanitär </th> <th>Material-Nr.</th> <th>Preis €uro/Stück</th> </tr> </thead> <tbody> <tr> <td>15 - 16 mm</td> <td>14 mm</td> <td>-</td> <td>100 Stück</td> <td></td> <td></td> <td>1135000573</td> <td>0,27</td> </tr> <tr> <td>17 - 18 mm</td> <td>17 mm</td> <td>-</td> <td>100 Stück</td> <td></td> <td></td> <td>1135000575</td> <td>0,34</td> </tr> <tr> <td>21 - 22 mm</td> <td>20 mm</td> <td>14 mm (16/21)</td> <td>100 Stück</td> <td></td> <td></td> <td>1135001364</td> <td>0,37</td> </tr> <tr> <td>27 - 28 mm</td> <td>25 mm 20 mm (23/28)</td> <td>17 mm (20/25),</td> <td>100 Stück</td> <td></td> <td></td> <td>1135000351</td> <td>0,41</td> </tr> <tr> <td>34 - 35 mm</td> <td>32 mm</td> <td>25 mm (28/34)</td> <td>100 Stück</td> <td></td> <td></td> <td>1135000791</td> <td>0,49</td> </tr> <tr> <td>39 - 40 mm</td> <td>-</td> <td>32 mm (36/42)</td> <td>100 Stück</td> <td></td> <td></td> <td>1135000792</td> <td>0,51</td> </tr> </tbody> </table>	Rohrschellen-abmessung	Rohrdimension ohne Schutzrohr	Rohrdimension ohne Schutzrohr	Verpackungseinheit mit Schutzrohr	Heizung	Sanitär	Material-Nr.	Preis €uro/Stück	15 - 16 mm	14 mm	-	100 Stück			1135000573	0,27	17 - 18 mm	17 mm	-	100 Stück			1135000575	0,34	21 - 22 mm	20 mm	14 mm (16/21)	100 Stück			1135001364	0,37	27 - 28 mm	25 mm 20 mm (23/28)	17 mm (20/25),	100 Stück			1135000351	0,41	34 - 35 mm	32 mm	25 mm (28/34)	100 Stück			1135000791	0,49	39 - 40 mm	-	32 mm (36/42)	100 Stück			1135000792	0,51				
Rohrschellen-abmessung	Rohrdimension ohne Schutzrohr	Rohrdimension ohne Schutzrohr	Verpackungseinheit mit Schutzrohr	Heizung	Sanitär	Material-Nr.	Preis €uro/Stück																																																						
15 - 16 mm	14 mm	-	100 Stück			1135000573	0,27																																																						
17 - 18 mm	17 mm	-	100 Stück			1135000575	0,34																																																						
21 - 22 mm	20 mm	14 mm (16/21)	100 Stück			1135001364	0,37																																																						
27 - 28 mm	25 mm 20 mm (23/28)	17 mm (20/25),	100 Stück			1135000351	0,41																																																						
34 - 35 mm	32 mm	25 mm (28/34)	100 Stück			1135000791	0,49																																																						
39 - 40 mm	-	32 mm (36/42)	100 Stück			1135000792	0,51																																																						
	<p>Roth Rohrschellen doppelt Zur Befestigung parallel verlaufender Roth Systemrohre Alu-Laserplus® auf der Rohdecke.</p> <table border="1"> <thead> <tr> <th>Rohrschellen-abmessung</th> <th>Rohrdimension ohne Schutzrohr</th> <th>Rohrdimension mit Schutzrohr</th> <th>Verpackungseinheit</th> <th>Heizung </th> <th>Sanitär </th> <th>Material-Nr.</th> <th>Preis €uro/Stück</th> </tr> </thead> <tbody> <tr> <td>15 - 16 mm</td> <td>14 mm</td> <td>-</td> <td>100 Stück</td> <td></td> <td></td> <td>1135000576</td> <td>0,83</td> </tr> <tr> <td>17 - 18 mm</td> <td>17 mm</td> <td>-</td> <td>100 Stück</td> <td></td> <td></td> <td>1135000574</td> <td>0,90</td> </tr> <tr> <td>21 - 22 mm</td> <td>20 mm</td> <td>14 mm (16/21)</td> <td>100 Stück</td> <td></td> <td></td> <td>1135001365</td> <td>1,10</td> </tr> <tr> <td>27 - 28 mm</td> <td>25 mm</td> <td>17 mm (20/25), 20 mm (23/28)</td> <td>100 Stück</td> <td></td> <td></td> <td>1135000349</td> <td>1,10</td> </tr> <tr> <td>34 - 35 mm</td> <td>32 mm</td> <td>25 mm (28/34)</td> <td>100 Stück</td> <td></td> <td></td> <td>1135000793</td> <td>1,20</td> </tr> <tr> <td>39 - 40 mm</td> <td>-</td> <td>32 mm (36/42)</td> <td>100 Stück</td> <td></td> <td></td> <td>1135000794</td> <td>1,20</td> </tr> </tbody> </table>	Rohrschellen-abmessung	Rohrdimension ohne Schutzrohr	Rohrdimension mit Schutzrohr	Verpackungseinheit	Heizung	Sanitär	Material-Nr.	Preis €uro/Stück	15 - 16 mm	14 mm	-	100 Stück			1135000576	0,83	17 - 18 mm	17 mm	-	100 Stück			1135000574	0,90	21 - 22 mm	20 mm	14 mm (16/21)	100 Stück			1135001365	1,10	27 - 28 mm	25 mm	17 mm (20/25), 20 mm (23/28)	100 Stück			1135000349	1,10	34 - 35 mm	32 mm	25 mm (28/34)	100 Stück			1135000793	1,20	39 - 40 mm	-	32 mm (36/42)	100 Stück			1135000794	1,20				
Rohrschellen-abmessung	Rohrdimension ohne Schutzrohr	Rohrdimension mit Schutzrohr	Verpackungseinheit	Heizung	Sanitär	Material-Nr.	Preis €uro/Stück																																																						
15 - 16 mm	14 mm	-	100 Stück			1135000576	0,83																																																						
17 - 18 mm	17 mm	-	100 Stück			1135000574	0,90																																																						
21 - 22 mm	20 mm	14 mm (16/21)	100 Stück			1135001365	1,10																																																						
27 - 28 mm	25 mm	17 mm (20/25), 20 mm (23/28)	100 Stück			1135000349	1,10																																																						
34 - 35 mm	32 mm	25 mm (28/34)	100 Stück			1135000793	1,20																																																						
39 - 40 mm	-	32 mm (36/42)	100 Stück			1135000794	1,20																																																						
	<p>Roth Einschlagnägel Zur Befestigung der Roth Rohrschellen auf dem Rohboden.</p> <p>Verpackungseinheit 100 Stück</p>			1135000352	€uro/Stück 0,16																																																								
	<p>Roth Setzeisen Zum Einschlagen der Roth Einschlagnägel.</p> <p>Verpackungseinheit 1 Stück</p>			1135000353	€uro/Stück 13,10																																																								
Roth Systemzubehör																																																													
	<p>Roth Einzelrosette Aus Kunststoff, Farbe weiß. Für den sauberen Übergang einzelner Roth HK-Anschlusswinkel, Roth HK-Anschluss-T-Stücke, Roth Systemrohre Alu-Laserplus® aus dem Boden, der Wand oder der Decke.</p> <p>Verpackungseinheit 10 Stück</p>			1135000371	€uro/Stück 1,40																																																								
	<p>Roth Doppelrosette Aus Kunststoff, Farbe weiß. Für den sauberen Übergang parallel angeordneter Roth HK-Anschlusswinkel, Roth HK-Anschluss-T-Stücke und Roth Systemrohre Alu-Laserplus® aus dem Boden, der Wand oder der Decke.</p> <table border="1"> <thead> <tr> <th>Achsabstand</th> <th>Verpackungseinheit</th> <th>Heizung </th> <th>Sanitär </th> <th>Material-Nr.</th> <th>Preis €uro/Stück</th> </tr> </thead> <tbody> <tr> <td>35 mm</td> <td>10 Stück</td> <td></td> <td></td> <td>1135000370</td> <td>2,60</td> </tr> <tr> <td>50 mm</td> <td>10 Stück</td> <td></td> <td></td> <td>1135000369</td> <td>2,60</td> </tr> </tbody> </table>	Achsabstand	Verpackungseinheit	Heizung	Sanitär	Material-Nr.	Preis €uro/Stück	35 mm	10 Stück			1135000370	2,60	50 mm	10 Stück			1135000369	2,60																																										
Achsabstand	Verpackungseinheit	Heizung	Sanitär	Material-Nr.	Preis €uro/Stück																																																								
35 mm	10 Stück			1135000370	2,60																																																								
50 mm	10 Stück			1135000369	2,60																																																								
	<p>Roth Schutzkappe 90° Aus LDPE-Kunststoff, geschlitzt, für die Aufnahme der Roth RG-Wandscheiben, zur Schallentkopplung und Schutz bei der Montage. Bestehend aus Schutzkappe 90°, Schutzrohrsicherungen und Schalldämmplatte.</p> <table border="1"> <thead> <tr> <th>Dimension</th> <th>Verpackungseinheit</th> <th>Heizung </th> <th>Sanitär </th> <th>Material-Nr.</th> <th>Preis €uro/Stück</th> </tr> </thead> <tbody> <tr> <td>17-20 mm*</td> <td>5 Stück</td> <td></td> <td></td> <td>1135000555</td> <td>4,10</td> </tr> <tr> <td>25 mm*</td> <td>5 Stück</td> <td></td> <td></td> <td>1135001382</td> <td>4,10</td> </tr> </tbody> </table>	Dimension	Verpackungseinheit	Heizung	Sanitär	Material-Nr.	Preis €uro/Stück	17-20 mm*	5 Stück			1135000555	4,10	25 mm*	5 Stück			1135001382	4,10																																										
Dimension	Verpackungseinheit	Heizung	Sanitär	Material-Nr.	Preis €uro/Stück																																																								
17-20 mm*	5 Stück			1135000555	4,10																																																								
25 mm*	5 Stück			1135001382	4,10																																																								

RIS











RIS

Montagewerkzeuge

Preisgruppe RIS

Artikel	Artikelbeschreibung	Heizung ◆	Sanitär ●	Material-Nr.	Preis €uro																		
	<p>Roth Elektro-Presswerkzeug ECO 202 Elektrisch angetriebenes Presswerkzeug, das in Verbindung mit den Roth Pressbacken bzw. der Roth Grundbacke mit den entsprechenden Roth Pressschlingen, die Herstellung unlösbarer Verbindungen zwischen den Roth Systemrohren, mit den entsprechenden Roth Anschluss- und Verbindungskomponenten ermöglicht. Das Elektro-Presswerkzeug wird in einem stabilen Transportkoffer geliefert. (Fabr. Novopress)</p>																						
	<p>Verpackungseinheit 1 Elektro-Presswerkzeug 1 Transportkoffer</p>			1135005464	<p>NETTOPREIS €uro/Stück 1.240,00</p>																		
	<p>Roth Akku-Presswerkzeug ACO 202 Elektrisches Pressgerät mit 18 Volt Lithium-Ionen-Akku, in Verbindung mit den Roth Pressbacken bzw. der Roth Grundbacke mit den entsprechenden Roth Pressschlingen, zur Herstellung unlösbarer Pressverbindungen zwischen den Roth Systemrohren mittels entsprechender Roth Anschluss- und Verbindungskomponenten. Das Roth Akku-Presswerkzeug wird im stabilen Transportkoffer mit Schnellladegerät geliefert. (Fabr. Novopress)</p>																						
	<p>Verpackungseinheit 1 Akku-Presswerkzeug (inkl. Akku); 1 Schnellladegerät 1 Transportkoffer</p>			1135005463	<p>NETTOPREIS €uro/Stück 1.402,00</p>																		
	<p>Roth Ersatzakku für Akku-Presswerkzeug ACO 202 18 Volt Lithium-Ionen-Akku passend für das Roth Akku-Presswerkzeug.</p>																						
	<p>Verpackungseinheit 1 Stück</p>			1135005465	<p>NETTOPREIS €uro/Stück 135,20</p>																		
	<p>Roth Pressbacke Verwendung/Einsatz mit dem Roth Elektro-Presswerkzeug, dem Roth Akku-Presswerkzeug oder baugleiche Werkzeuge (siehe Info-Blatt Roth Presstechnik) in Verbindung mit den Roth Systemkomponenten.</p>																						
	<table border="0"> <tr> <td>Dimension</td> <td>Verpackungseinheit</td> <td></td> </tr> <tr> <td>14 mm</td> <td>1 Stück</td> <td>1135000333</td> </tr> <tr> <td>17 mm</td> <td>1 Stück</td> <td>1135000334</td> </tr> <tr> <td>20 mm</td> <td>1 Stück</td> <td>1135000335</td> </tr> <tr> <td>25 mm</td> <td>1 Stück</td> <td>1135001402</td> </tr> <tr> <td>32 mm</td> <td>1 Stück</td> <td>1135001403</td> </tr> </table>	Dimension	Verpackungseinheit		14 mm	1 Stück	1135000333	17 mm	1 Stück	1135000334	20 mm	1 Stück	1135000335	25 mm	1 Stück	1135001402	32 mm	1 Stück	1135001403				<p>NETTOPREIS €uro/Stück</p> <p>156,20 159,40 162,70 169,90 173,30</p>
Dimension	Verpackungseinheit																						
14 mm	1 Stück	1135000333																					
17 mm	1 Stück	1135000334																					
20 mm	1 Stück	1135000335																					
25 mm	1 Stück	1135001402																					
32 mm	1 Stück	1135001403																					
	<p>Roth Akku-Presswerkzeug AFP 101 Wird im stabilen Transportkoffer mit Schnellladegerät geliefert. (Fabr. Novopress)</p>																						
	<p>Verpackungseinheit 1 Akku-Presswerkzeug inklusive 2 Akkus 1 Turbo-Akku-Ladegerät 1 Transportkoffer je 1 Pressbacke 14, 17, 20, 25 und 32 mm</p>			1135003901	<p>NETTOPREIS €uro/Stück 1.457,00</p>																		
	<p>Roth Pressbacke für Presswerkzeug AFP 101</p>																						
	<table border="0"> <tr> <td>Dimension</td> <td>Verpackungseinheit</td> <td></td> </tr> <tr> <td>14 mm</td> <td>1 Stück</td> <td>1135003904</td> </tr> <tr> <td>17 mm</td> <td>1 Stück</td> <td>1135003906</td> </tr> <tr> <td>20 mm</td> <td>1 Stück</td> <td>1135003907</td> </tr> <tr> <td>25 mm</td> <td>1 Stück</td> <td>1135003908</td> </tr> <tr> <td>32 mm</td> <td>1 Stück</td> <td>1135003909</td> </tr> </table>	Dimension	Verpackungseinheit		14 mm	1 Stück	1135003904	17 mm	1 Stück	1135003906	20 mm	1 Stück	1135003907	25 mm	1 Stück	1135003908	32 mm	1 Stück	1135003909				<p>NETTOPREIS €uro/Stück</p> <p>104,90 104,90 104,90 104,90 104,90</p>
Dimension	Verpackungseinheit																						
14 mm	1 Stück	1135003904																					
17 mm	1 Stück	1135003906																					
20 mm	1 Stück	1135003907																					
25 mm	1 Stück	1135003908																					
32 mm	1 Stück	1135003909																					
	<p>Roth Netzadapter für Presswerkzeug AFP 101 Der Roth-Netzadapter AFP 101 ermöglicht die Nutzung des Roth Presswerkzeuges AFP 101 als Netzgerät.</p>																						
				1135004121	<p>NETTOPREIS €uro/Stück 299,00</p>																		











RIS		Roth Montagewerkzeuge		Preisgruppe RIS		
Artikel	Artikelbeschreibung	Heizung ◆	Sanitär ●	Material-Nr.	Preis €uro	
	Roth Ersatzakku für Presswerkzeug AFP 101 9,6 Volt Hochleistungsakku passend für das Roth Akku-Presswerkzeug AFP 101.			1135003910	NETTOPREIS €uro/Stück 138,00	
	Roth Turbo-Akku-Ladegerät für Presswerkzeug AFP 101 Schnellladegerät für Akkus Typ AFP 101.			1135003911	NETTOPREIS €uro/Stück 121,40	
	Roth Koffer für Pressbacken 14 bis 32 mm Für den sicheren Transport und zur schonenden Aufbewahrung der Roth Pressbacken 14 bis 32 mm			Verpackungseinheit 1 Stück	NETTOPREIS €uro/Stück 76,20	
	Roth Grundbacke für Pressschlinge Zur Aufnahme der Roth Pressschlingen. Verwendung/Einsatz in Verbindung mit dem Roth Elektro-Presswerkzeug und Roth Akku-Presswerkzeug und den von Roth freigegebenen Presswerkzeugen.			Verpackungseinheit 1 Stück	NETTOPREIS €uro/Stück 291,00	
	Roth Pressschlinge Nur in Verbindung mit der Roth Grundbacke für Pressschlingen 40, 50 und 63 mm einsetzbar.			Dimension 40 mm 50 mm 63 mm	Verpackungseinheit 1 Stück 1 Stück 1 Stück	NETTOPREIS €uro/Stück 616,00 633,00 1.035,00
	Roth Koffer für Grundbacke und Pressschlingen Für den sicheren Transport und zur schonenden Aufbewahrung der Roth Grundbacke und Roth Pressschlingen.			Verpackungseinheit Roth Grundbacke/Roth Pressschlingen 40 - 50 mm Roth Grundbacke und der Roth Pressschlingen 40 - 63 mm	1 Stück 1 Stück	NETTOPREIS €uro/Stück 76,20 153,40
	Roth Schutzrohrabschneider Zum sicheren Ablängen der Schutzrohre bis zu einem Durchmesser von 42 mm.			Verpackungseinheit 1 Stück	NETTOPREIS €uro/Stück 21,80	
	Roth Rohrschere Zum Ablängen der Roth Systemrohre Alu-Laserplus®.			Verpackungseinheit 1 Stück	NETTOPREIS €uro/Stück 28,00	
	Roth Rohrschneider Zum Ablängen der Roth Systemrohre Alu-Laserplus®, Ø 14 bis 63 mm.			Verpackungseinheit 1 Stück	NETTOPREIS €uro/Stück 83,60	
	Roth Kalibrierwerkzeug Universalwerkzeug zum Kalibrieren der Roth Systemrohre Alu-Laserplus® und Entgraten der PE-Basisrohre, versehen mit drei bzw. zwei Kalibrierdornen, bzw. als Einzelkalibrierer, abgestimmt auf die Roth Systemrohrdimensionen.			Dimension 14, 17, 20 mm 25, 32 mm 40 mm 50 mm 63 mm	Verpackungseinheit 1 Stück 1 Stück 1 Stück 1 Stück 1 Stück	NETTOPREIS €uro/Stück 34,10 34,90 49,70 54,00 93,20

RIS

RIS

Roth Montagewerkzeuge

Preisgruppe RIS

Artikel	Artikelbeschreibung	Heizung ◆	Sanitär ●	Material-Nr.	Preis €uro
	Roth Einzelkalibrierer Kalibrier- und Anfaswerkzeug für Roth Systemrohre Alu-Laserplus®, zur manuellen oder maschinellen Verwendung in Bohrmaschinen und Akkuschraubern oder mit dem Roth Handgriff für Einzelkalibrierer.				NETTOPREIS €uro/Stück
	Dimension	Verpackungseinheit			
	14 mm	1 Stück		1135005172	21,00
	17 mm	1 Stück		1135005174	21,30
	20 mm	1 Stück		1135005175	21,60
	25 mm	1 Stück		1135005176	22,70
	32 mm	1 Stück		1135005177	24,40
	40 mm	1 Stück		1135005511	34,60
50 mm	1 Stück		1135005512	39,70	
63 mm	1 Stück		1135005513	51,50	
	Roth Handgriff für Einzelkalibrierer Handgriff mit Schnellverschluss für die manuelle Verwendung der Roth Einzelkalibrierer.				NETTOPREIS €uro/Stück
		Verpackungseinheit		1135005178	12,10
	Roth Einzelkalibrierer Set Set bestehend aus den Roth Einzelkalibrierern in den Dimensionen 14, 17, 20, 25 und 32 mm, sowie dem Roth Handgriff für Einzelkalibrierer und Transportkoffer zur Aufbewahrung der Werkzeuge.				NETTOPREIS €uro/Stück
	Dimension	Verpackungseinheit		1135004931	126,80
	Roth Rohrrichter 14 bis 25 mm Roth Rohrrichter, zum geraden Ausrichten von Roth Systemrohren Alu-Laserplus® der Dimensionen 14 bis 25 mm (Rollenware), in Stangenware. Optional: In Kombination mit dem Roth Adapter für Rohrrichter, montierbar auf Roth Abroller faltbar.				NETTOPREIS €uro/Stück
		Verpackungseinheit		1135003961	304,00
	Roth Adapter für Roth Rohrrichter 14 bis 25 mm Adapter zur Befestigung des Roth Rohrrichters 14 bis 25 mm, an dem Roth Abroller faltbar.				NETTOPREIS €uro/Stück
		Verpackungseinheit		1135003962	33,80
	Roth Abroller faltbar Die kompakte Ausführung eines faltbaren Abrollers (4-armig) für die ideale und rationelle Verlegung aller Roth Rohrbundgrößen bis 600 m. Die gefaltete Länge des Abrollers beträgt nur 900 mm, das Gewicht beträgt nur 12,5 kg. Zulässige Tragkraft ca. 90 kg, max. Kerndurchmesser ca. 630 mm, max. Ringhöhe 600 mm komplett verstellbar.				NETTOPREIS €uro/Stück
		Verpackungseinheit		1135003461	324,00
	Roth Biegefeder außen Zum Biegen von Hand der Roth Systemrohre Alu-Laserplus® mit außen auf-gebrachter Biegefeder.				NETTOPREIS €uro/Stück
	Dimension	Verpackungseinheit			
	14 mm x 300 mm	1 Stück	◆	1135000579	5,50
	17 mm x 350 mm	1 Stück	◆ ●	1135000580	6,10
20 mm x 400 mm	1 Stück	◆ ●	1135000581	6,70	
	Roth Biegefeder innen Einsteckbiegefeder zum fachgerechten Biegen der Roth Systemrohre Alu-Laserplus® von Hand.				NETTOPREIS €uro/Stück
	Dimension	Verpackungseinheit			
	14 mm x 1600 mm	1 Stück	◆	1135001658	13,60
	17 mm x 1600 mm	1 Stück	◆ ●	1135001659	18,40
	20 mm x 1600 mm	1 Stück	◆ ●	1135001660	23,20
25 mm x 1600 mm	1 Stück	◆ ●	1135004311	23,80	

